

FL-FB120

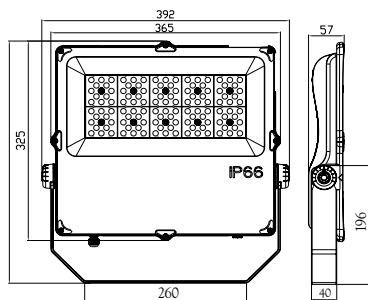

SPECIFICATION

Model Code	FL-FB120
Power	120W
Efficiency	110lm/W (4000K)
Input Voltage	100-240VAC
Size	325x365x57mm
Body Color	Black
LED Source	Lumileds (USA)
CRI	Ra>80
Beam Angle	15°/ 20°/ 60°/ 90°/ 120°/ T2M/ T3M
CCT	2700K/ 3000K/ 4000K/ 5700K/ Color
Lume	12.580lm(W), 13.200lm(N/C)
Life time	Min 30.000h
IP	IP66
Weight	4.5kg

PHOTOMETRIC CURVES Beam Angle 120°

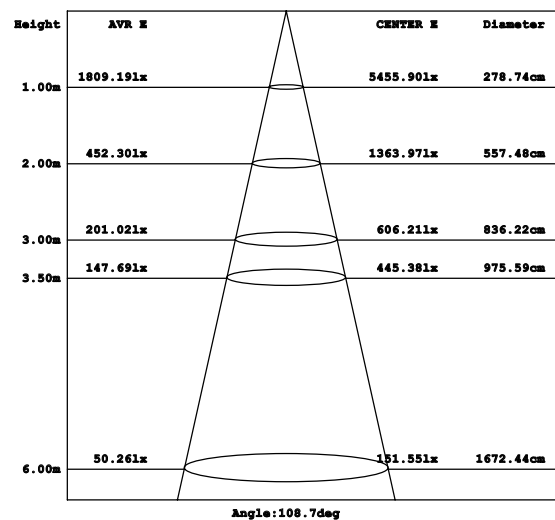
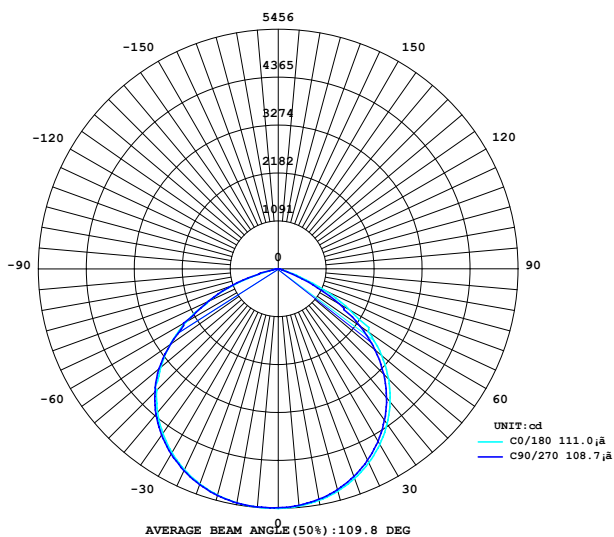

INSTALLATION INSTRUCTIONS

1. Remove frame out of the light

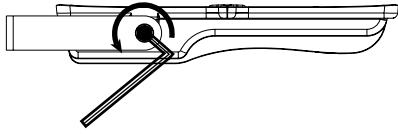

2. Attach the bracket fixed to the position to install the lamp

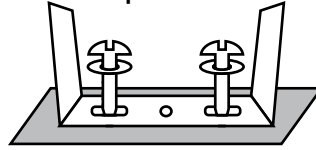

3. Install the lights on the fixed racks

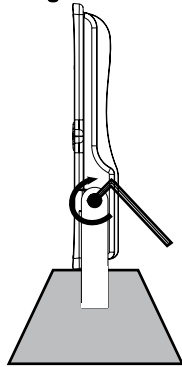

4. connect the wires to the source 220VAC

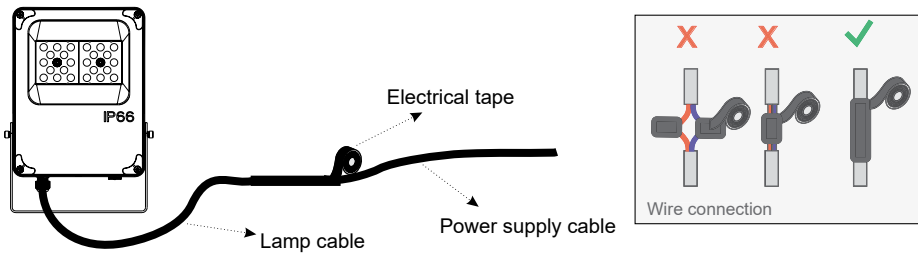
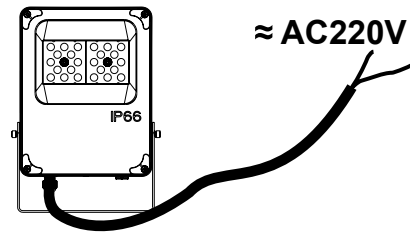

Attention :

1. Install by qualified electricians only .
2. Make sure that the supply voltage is disconnected before installation.
3. Make sure the voltage is suitable with the lamps ,and L/N/G connect properly.
4. Don't open the lamps without Manufacturer's Authorized

PACKING

Power	Package size	Quantity/Cartons	Carton size
120W	L440xW420xH115mm	1	-

