

FL-FB30

RoHS

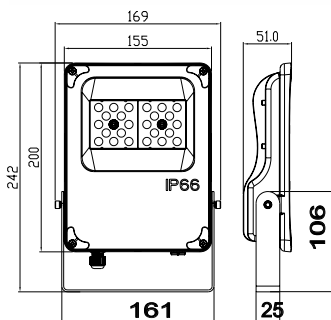

SPECIFICATION

Model Code	FL-FB30
Power	30W
Efficiency	110lm/W (4000K)
Input Voltage	100-240VAC
Size	200x155x51mm
Body Color	Black
LED Source	Lumileds (USA)
CRI	Ra>80
Beam Angle	15°/ 20°/ 60°/ 90°/ 120°/ T2M/ T3M
CCT	2700K/ 3000K/ 4000K/ 5700K/ Red/ Green/ Blue
Lumen	3.000lm(W), 3.300lm(N/C)
Life time	Min 50.000h
IP	IP66
Weight	1.2kg

PHOTOMETRIC CURVES Beam Angle 120°

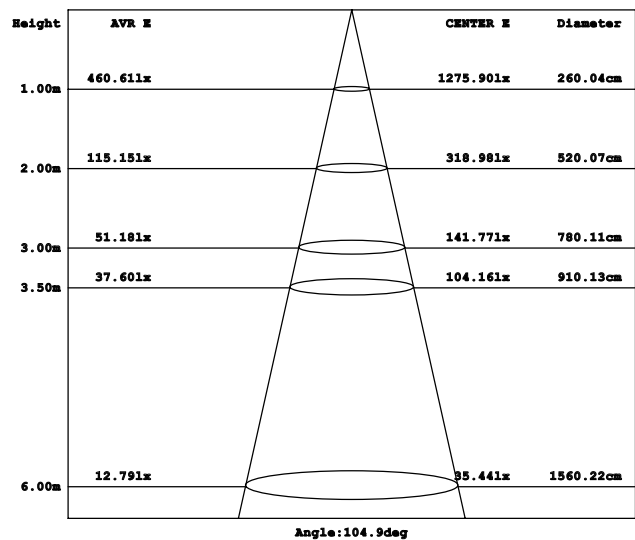
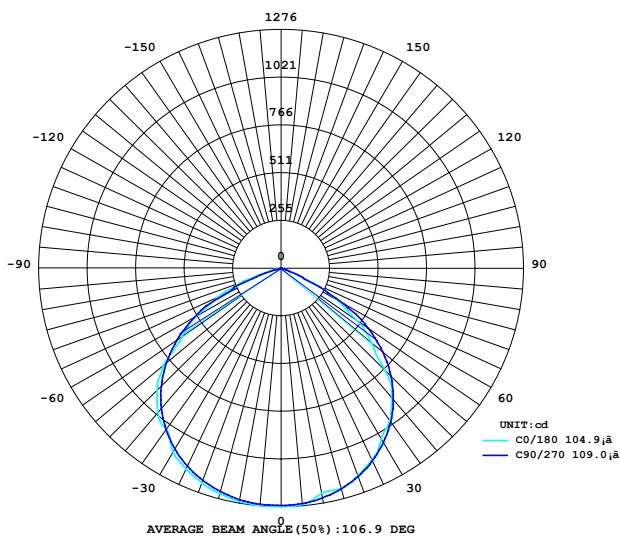

INSTALLATION INSTRUCTIONS

1. Remove frame out of the light

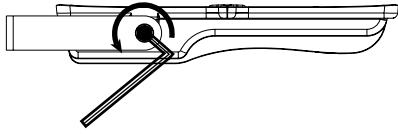

2. Attach the bracket fixed to the position to install the lamp

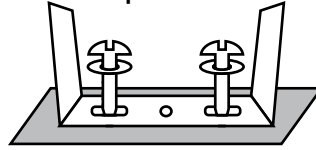

3. Install the lights on the fixed racks

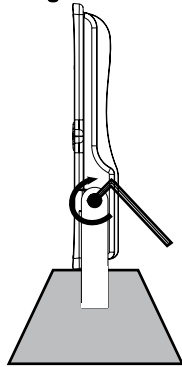

4. connect the wires to the source 220VAC

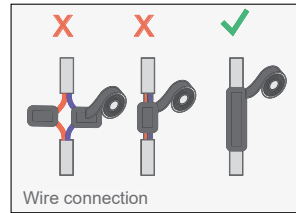
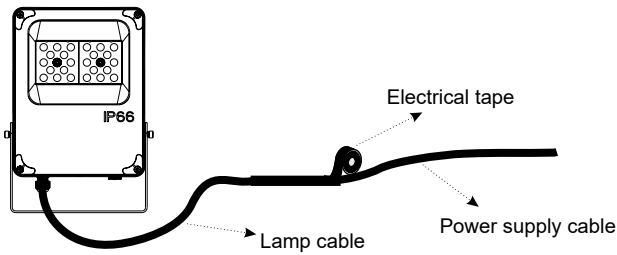
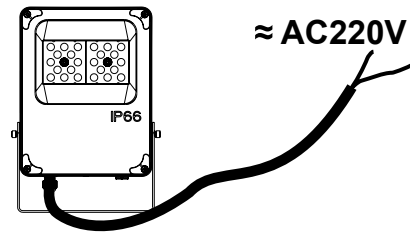

Attention :

1. Install by qualified electricians only .
2. Make sure that the supply voltage is disconnected before installation.
3. Make sure the voltage is suitable with the lamps ,and L/N/G connect properly.
4. Don't open the lamps without Manufacturer's Authorized

PACKING

Power	Package size	Quantity/Cartons	Carton size
30W	L255xW170xH60mm	18	L540xW360xH310mm

