

HB-DS80

RoHS

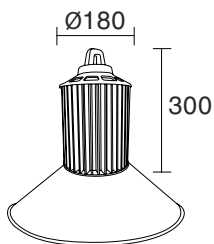

SPECIFICATION

Model Code	HB-DS80
Power	80W
Efficiency	120lm/w (4000K)
Input Voltage	100-240VAC
Size	Ø180x300mm
Body Color	Silver
Weight	3.1kg
LED Source	Lumileds (USA)
CRI	Ra>80
Beam Angle	45°/ 60°/ 90°/ 120°
CCT	3000K/ 4000K/ 5700K
Lumen	9.240lm(W), 9.600lm(N/C)
Life time	Min 50.000h
IP	IP40

PHOTOMETRIC CURVES Beam Angle 90°

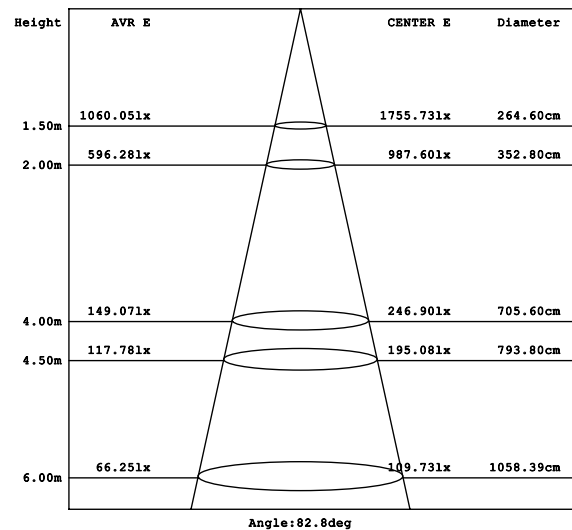
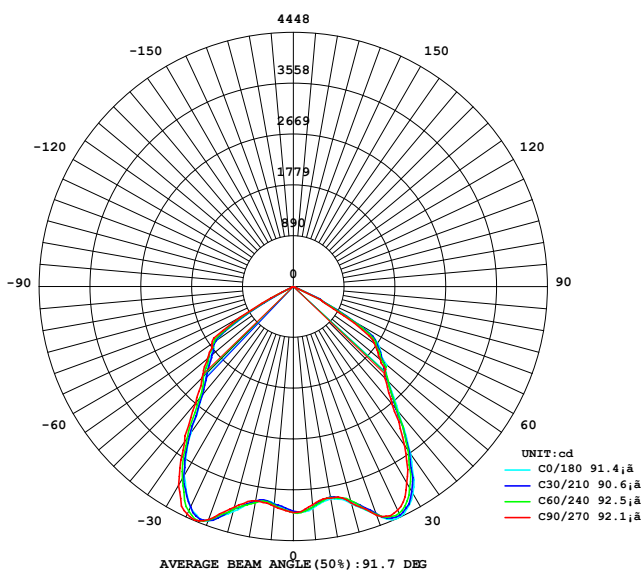

INSTALLATION INSTRUCTIONS

1. Assemble the screws and reflective cover

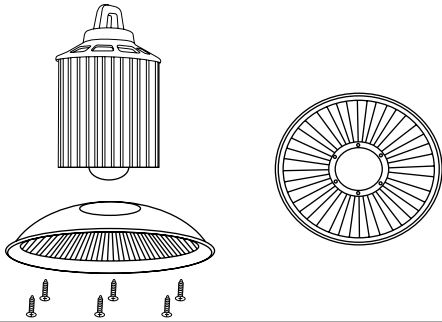

2. Install the hook and make sure the hook can support the weight of the light

Ceiling



3. Put the lamp on the hook

Ceiling

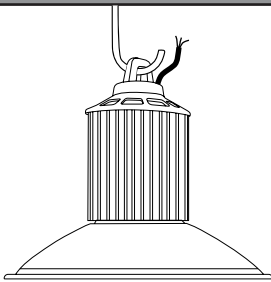

4. connect the power lead to mains supply

Ceiling

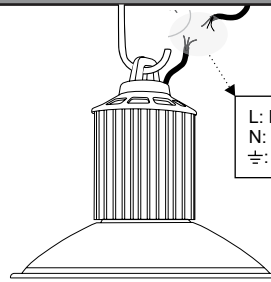

Note: - Disconnect the power supply before connecting the power
 - Need to activate the warranty before use. If not activated, the applicable time is the factory time.

PACKING

Power	Package size	Quantity/Cartons	Carton size
80W	L250xW250xH390mm	1	-

