

PF-3594S80 / PF-3594B80

RoHS

CE

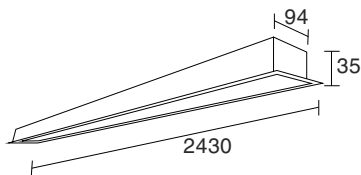

2415x84mm

SPECIFICATION

Model Code	PF-3594S80 / PF-3594B80
Power	80W
Efficiency	105lm/W (4000K)
Input Voltage	100-240VAC / 24VDC
Size	2430x94x35mm
Hole size	2415x84mm
Body Color	Silver/ Black
LED Source	Bridgelux (USA)
CRI	Ra>80
Beam Angle	105°
CCT	3000K/ 4000K/ 6500K
Lumen	8110lm(W), 8400lm(N/C)
Life time	Min 30.000h
IP	IP40

PHOTOMETRIC CURVES

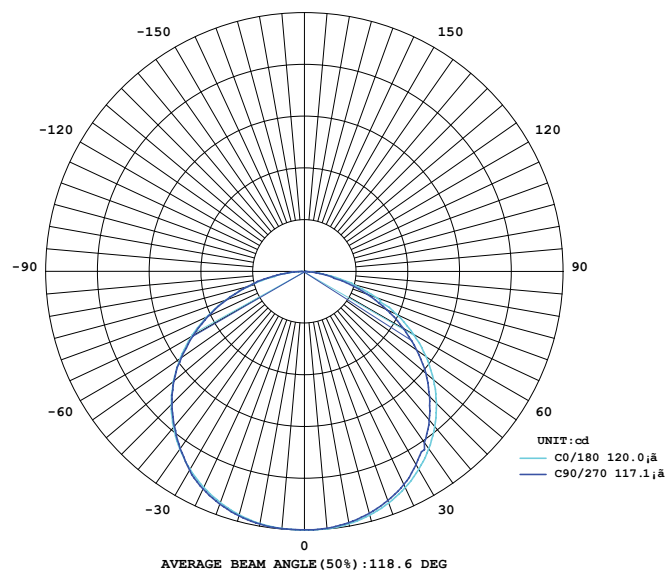

INSTALLATION INSTRUCTIONS

1. Drill a hole on the ceiling

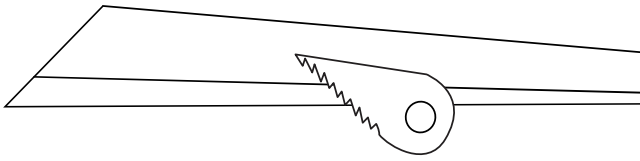

2. Remove the Endcap from the Profile

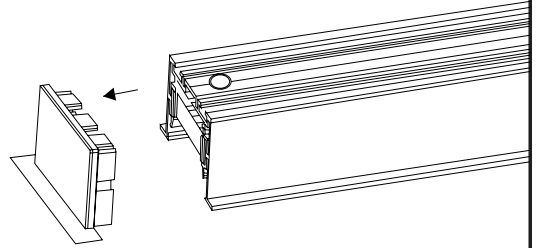

3. Insert the recessed into the Profile

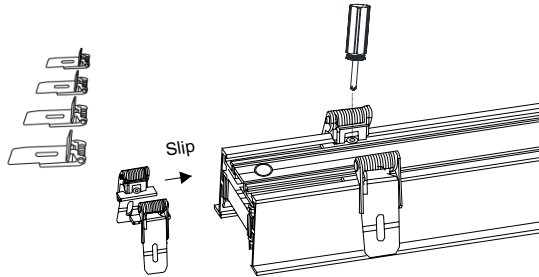

4. Close the Endcap

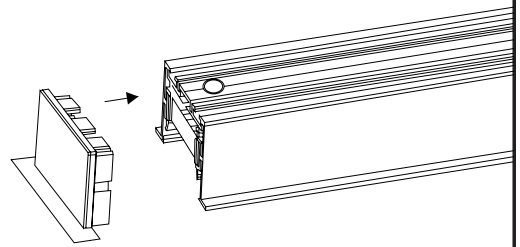

5. Connect LED driver to the power supply Connect LED driver to the Profile

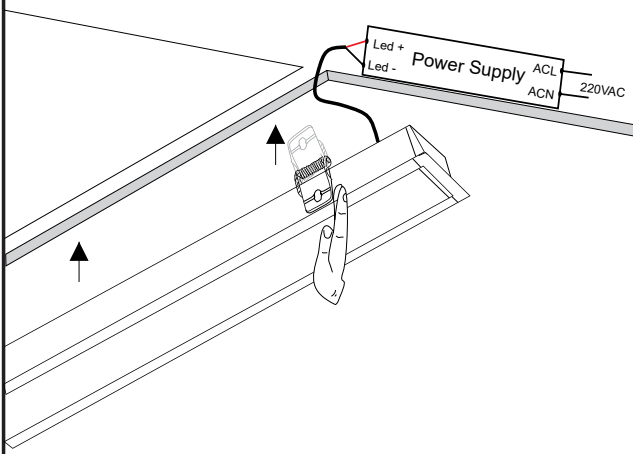

6. Finished installation

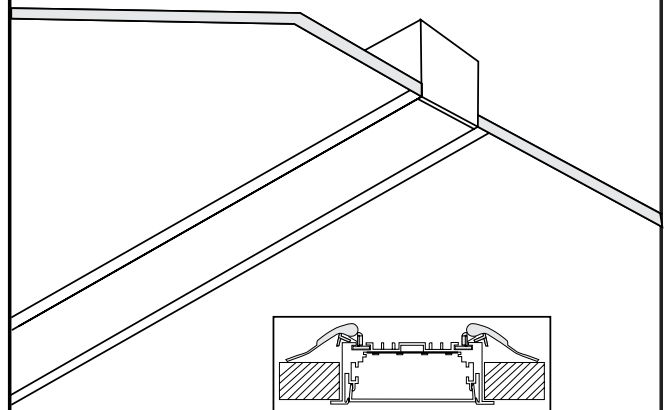

Note: - Disconnect the power supply before connecting the power
- Need to activate the warranty before use. If not activated, the applicable time is the factory time.

PACKING

