

3000K 4000K 5000K

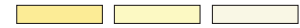

IP65

>30,000
Hours

220-240
VAC

RoHS



DL-TW35

White

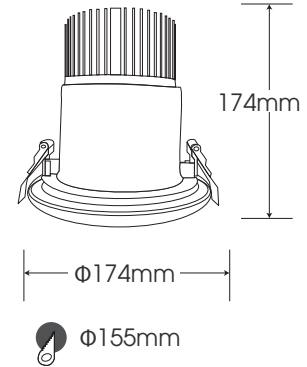

Model	Power	Led source	Beam angle	CCT	CRI	Flux
DL-TW35	35W	CREE (USA)	24° / 36° / 60°	3000K	>80	1915lm
				4000K	>80	2365lm
				5000K	>80	2365lm

LAMP PHOTOMETRIC REPORT

AVERAGE AND CENTER E Figure

ISOLUX DIAGRAM

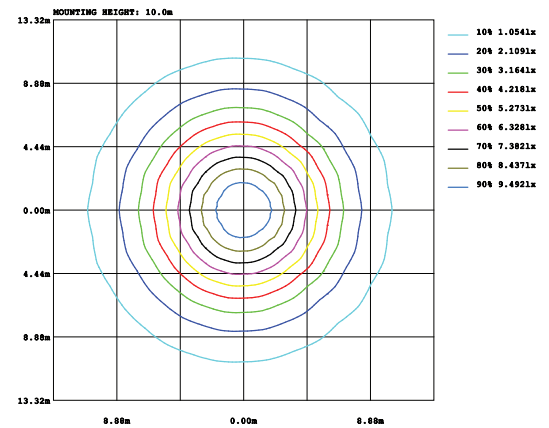
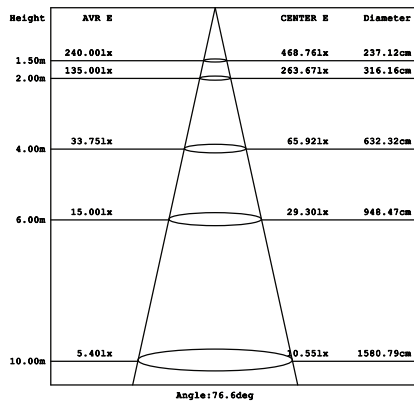
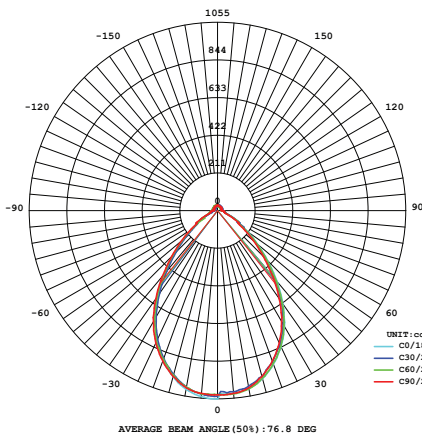

Parameter of DL-TW35 | CCT 4000K

INSTALLATION INSTRUCTIONS

PACKING

1. Ceiling cut

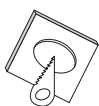

Size cut: Ø155mm

2. Connected Led Driver with 220VAC power
3. Connected Led Driver with lamp

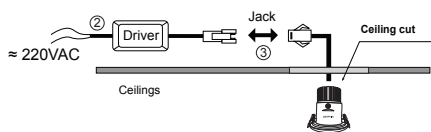

4. Put the lamp on the ceiling



1 pcs →

190mm

